

# DVR – LIVCAP Series

Hardware Installation Guide

Rev. 1.5

Digital Video Security System  
Digital Video Recorder

**[www.cctvone.com](http://www.cctvone.com)**

CCTVONE.

\*All contents of this document may change without prior notice, and actual product appearance may differ from depicted herein

# INDEX

<b>1. Specification of DVR</b>	.....	3
<b>2. Products and components</b>	.....	5
2-1. DVR Board	.....	5
2-2. Accessories	.....	5
<b>3. Board Description</b>	.....	6
3-1. 24016LIV	.....	6
3-2. 12016LIV	.....	6
3-3. 240N16	.....	7
3-4. 120N16	.....	7
3-5. 240N32	.....	8
3-6. 480N32	.....	9
<b>4. Installation</b>	.....	10
4-1. 120N16 / 240N16 / 12016LIV / 24016LIV Installation	.....	10
4-1-1. Pigtail type	.....	10
4-1-2. Back panel type	.....	11
4-2. 240N32 Installation	.....	12
4-3. 480N32 Installation	.....	13
<b>5. Accessories</b>	.....	14
5-1. Back panel	.....	14
5-2. Pigtail	.....	15
5-3. Sensor Board	.....	15
5-4. RS-232 to RS-485 Converter	.....	16
5-5. Sound Recording	.....	17
5-5-1. 1 channel sound	.....	17
5-5-2. 2 channel sound	.....	17

## Preface

This is a guide book that explains the hardware components and provides a step-by-step installation of DVR board.

For the software explanation, please refer to “Installation and User’s Guide”.

This guide book is applicable to, among DVR products, 24016LIV, 12016LIV, 240N16, 120N16, 240N32, and 480N32 board.

The pictures and name of the products are subject to change; however, the usage may be similar.

For any questions you have, please contact to the following address. When sending your concerned matter, please include your company name and phone number with detailed descriptions.

E-mail: [support@cctvone.com](mailto:support@cctvone.com)

Tel: 323-721-8999

Fax: 323-721-8599

[www.cctvone.com](http://www.cctvone.com)

# 1. Specification of DVR

- **1~32 Camera Inputs / Output**

Up to 32 camera inputs are available on screen for digital handling.

Normal input condition: 75 Ohm, 1 Volt ( p-p )

- **1~16 Sensor Inputs**

Up to 16 sensors can be linked to the system.

External DC 12 Volt power must be provided to the sensor input from outside.

- **1~4 Digital Outputs (Relay Outputs)**

Digital Outputs can be used to activate things like shutters and sirens, and activation can be linked to sensor and motion detection.

- **Sound Recording and Two-Way Communication Capabilities**

Sound can be recorded with video images. Two-way communication is possible between DVR main and DVR Net.

- **Display Features (w/ Multi-Viewing)**

Multi-Viewing allows 1, 4, 6, 9, 10, or 16 different camera shots to be displayed onscreen at the same time.

Other display features include enlarging all displayed cameras or just one. 32 channel viewing can be attained with specially configured cards.

- **PAN/TILT/ZOOM/FOCUS Capabilities**

Each connected camera can be manipulated through the DVR main program as long as each camera supports such capabilities.

- **Auto Rebooting System**

When DVR detects an error or malfunction within the system, it will automatically reboot the system in order to correct it.

- **Motion Detection and Sensor Trigger**

Detection features make it possible to record images only when movement is detected, preserving volume space and maximizing the use of physical storage space.

- **Scheduled Recording**

Scheduling allows the administrator to record images only during designated time periods, if so desired. Every combination of scheduling is available in the DVR program.

- **Manual and Auto Backup**

Data can be preserved through various formats (DAT, CD, or DVD) and data from specific cameras and/or time periods can be specifically isolated for backup as well. Much like scheduled recording, backup of data can be scheduled as well.

- **Digitalized Video Search**

Recorded data features digital playback for each camera simultaneously or one at a time. Playback features include advanced search features and image extracting, which allows portions of existing video to be extracted and saved as a separate file.

- **Network Support (PSTN, TCP/IP, LAN , Modem Protocol Support)**

DVR supports network access, which allows administrators to login to DVR main and remotely access all the features provided locally.

- **POS, Access Control, ATM Support**

Data from external devices (POS, Access Control, ATM, etc) can be recorded with DVR video images. Text Search allows to search data from external devices with DVR video image when event occurs. This will raise the level of integrity and security.

Feature	LIVCAP Series
Camera Input	1~32Port(NTSC/PAL)
Sound Input	1 or 2 Port
Sensor Input	1~16 Port
Relay Output	1~4 Port
Composite Output	1 Port (NTSC/PAL, Split and/or Switching)
Image Format	Software MPEG-4
Recording Mode	Watch, Normal, Motion Detection, Sensor, Scheduled Recording
Remote Control	Full remote control PSTN, ISDN,ADSL, LAN and TCP/IP
Back-up	DAT, CD, DVD
PAN/TILT/ZOOM/FOCUS	RS-232/422/485 Interface

*Note: 32 channel products consist of Master and Slave boards, which controls 16 channels of video each.*

## 2. Products and Components

### 2.1 DVR LIVCAP Series Board



120N16



12016LIV

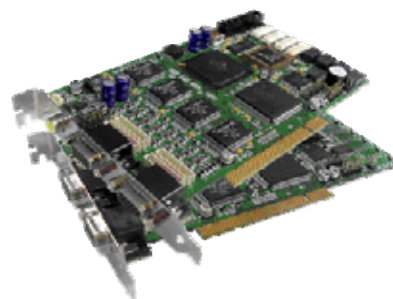

240N32  
(2 Boards. Master & Slave)



240N16



24016LIV



480N32  
(2 Boards. Master & Slave)

### 2.2 Accessories



Pigtail Cable



RS-485 Board



RS-232C Cable



Sensor Cable



Audio Cable



Reset Cable



TV-OUT Cable  
(32 Ch. Only)



Sensor Port



Back Panel  
(Optional)



Video Cable  
(Optional)

### 3. Board Description

#### 3-1. 24016LIV

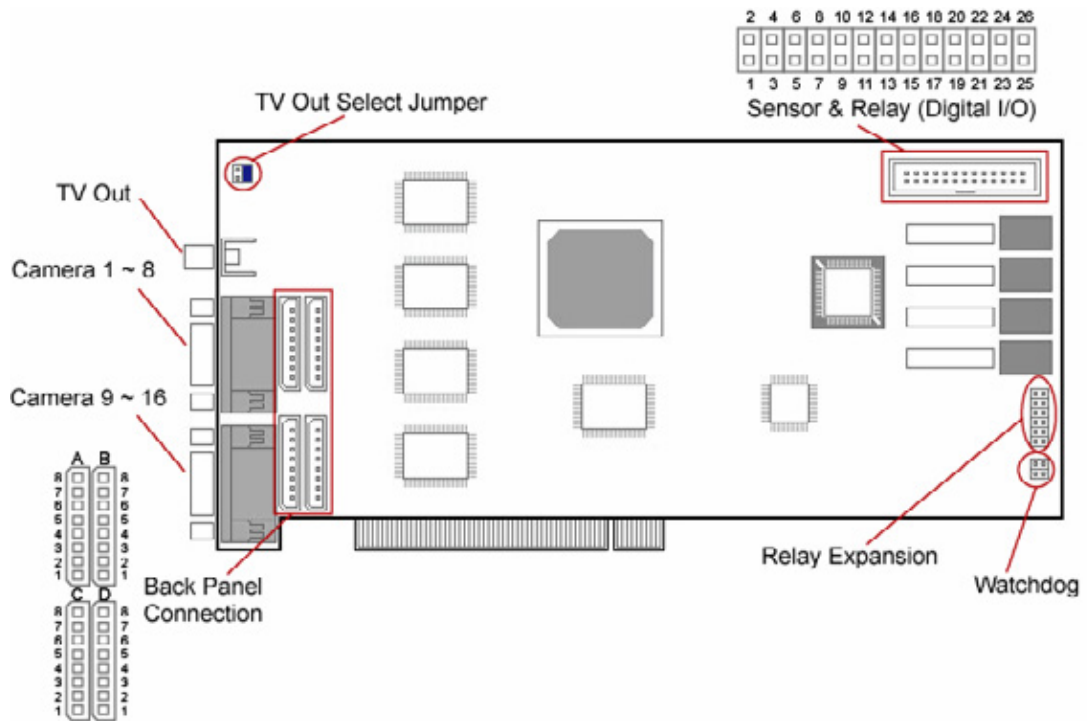

#### 3-2. 12016LIV

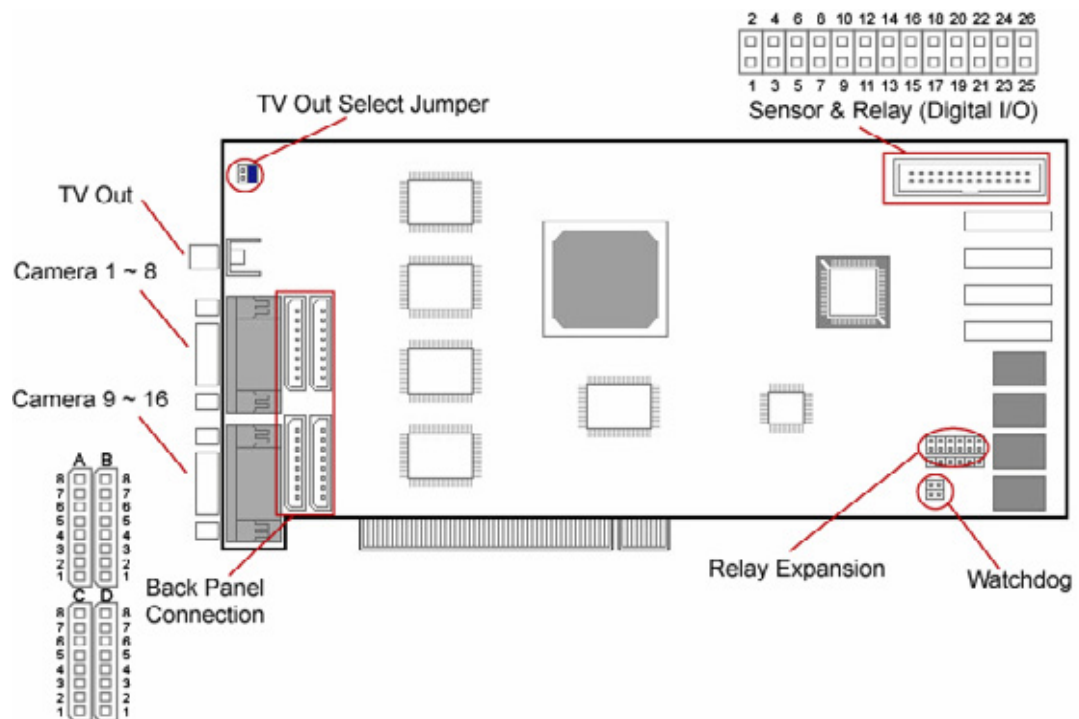

### 3-3. 240N16

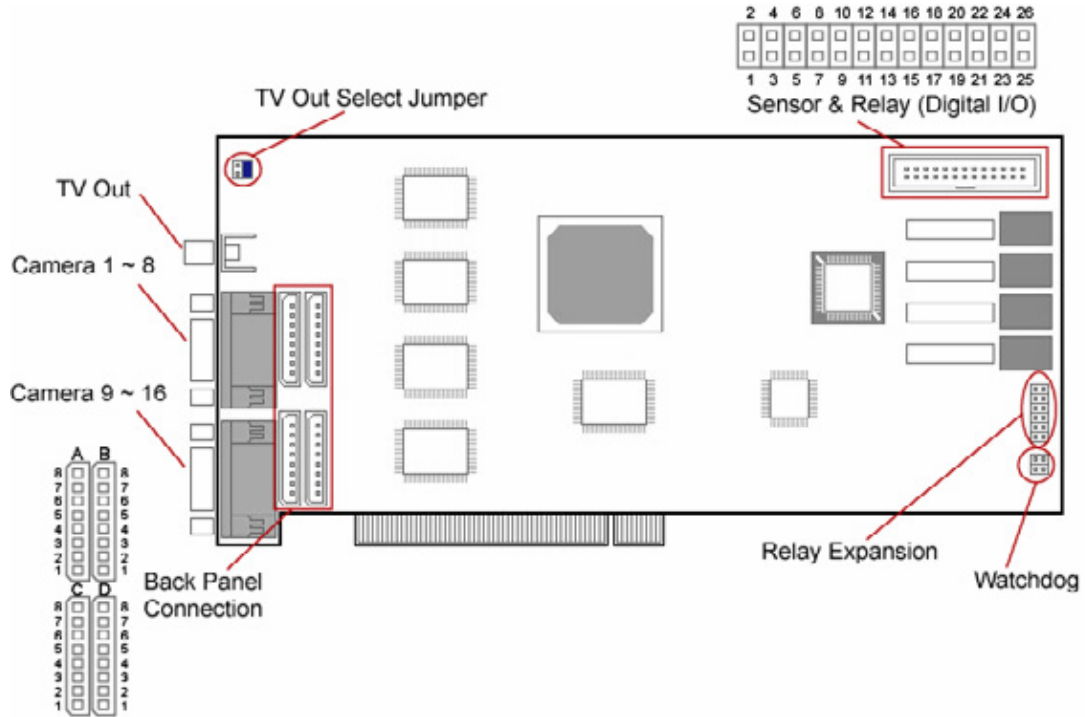

### 3-4. 120N16

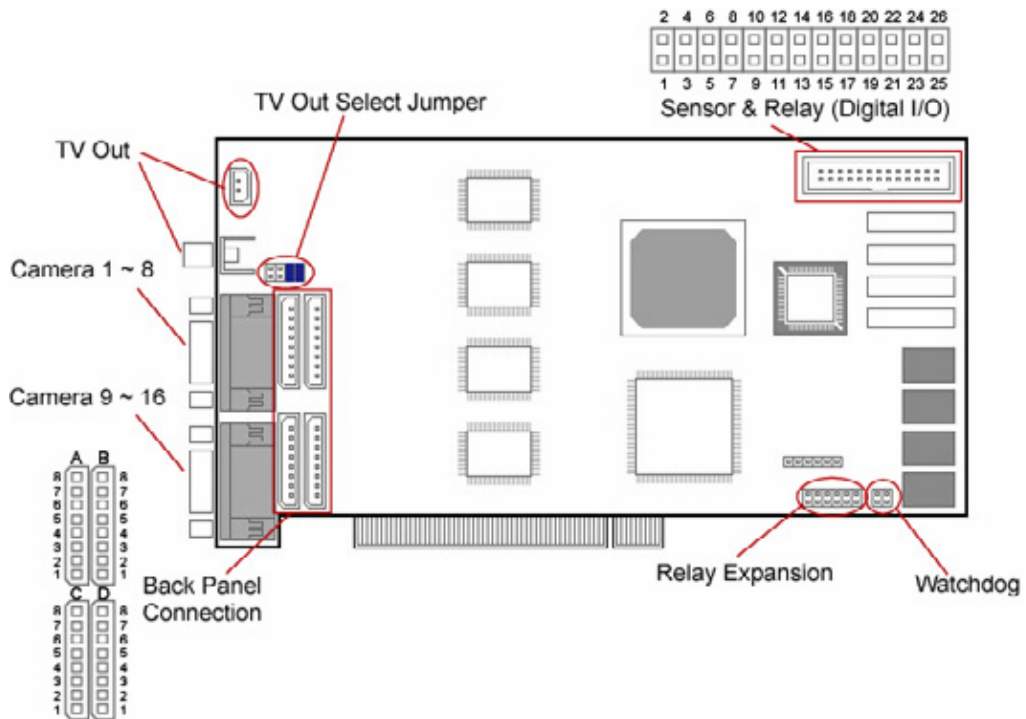



### 3-5. 240N32

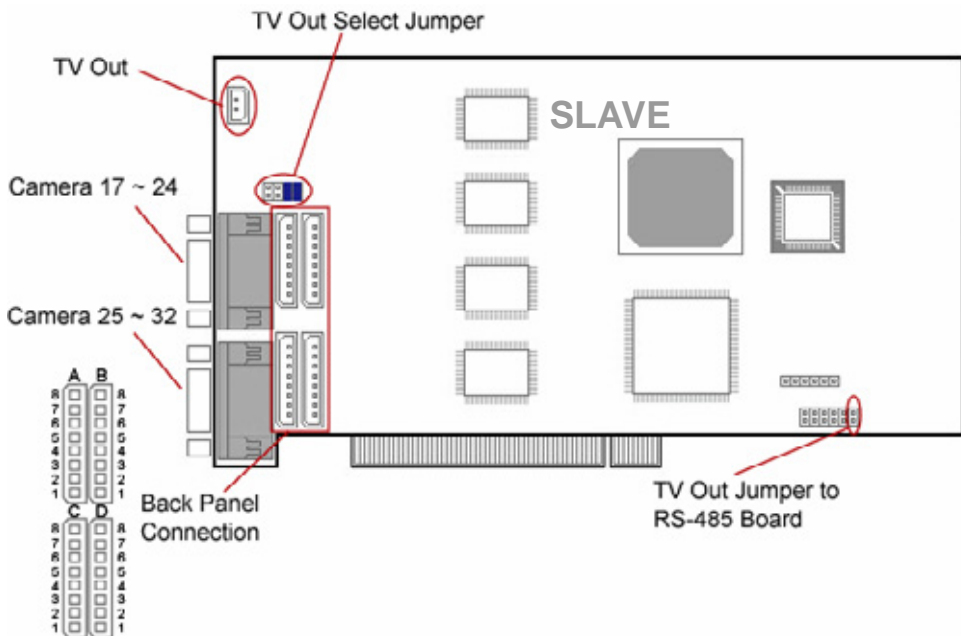
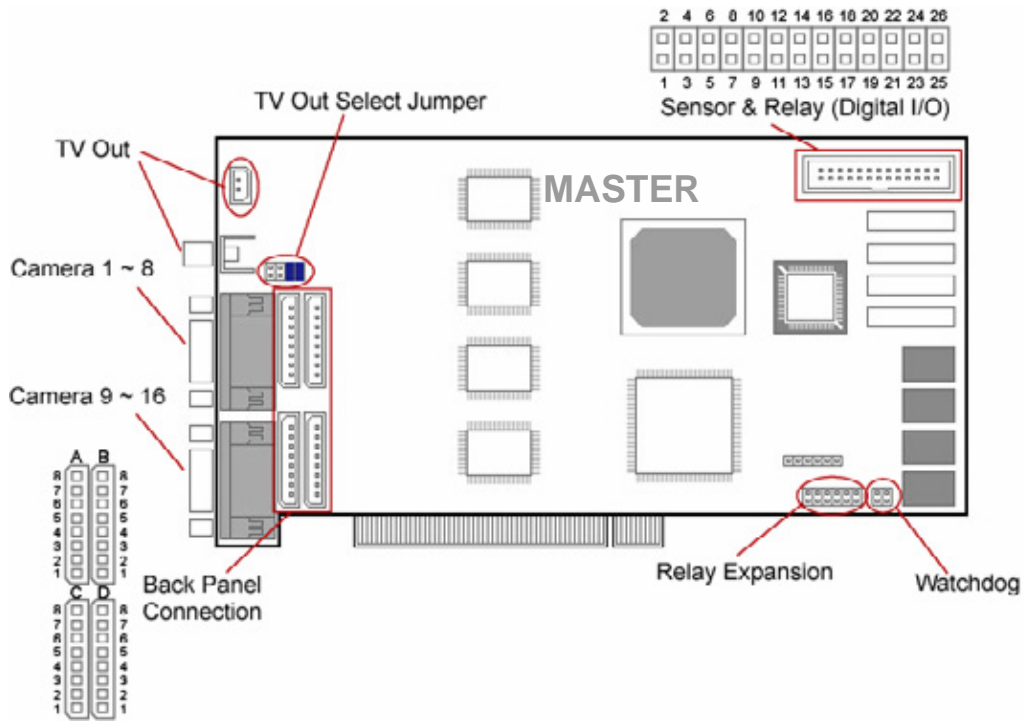

### 3-6. 480N32

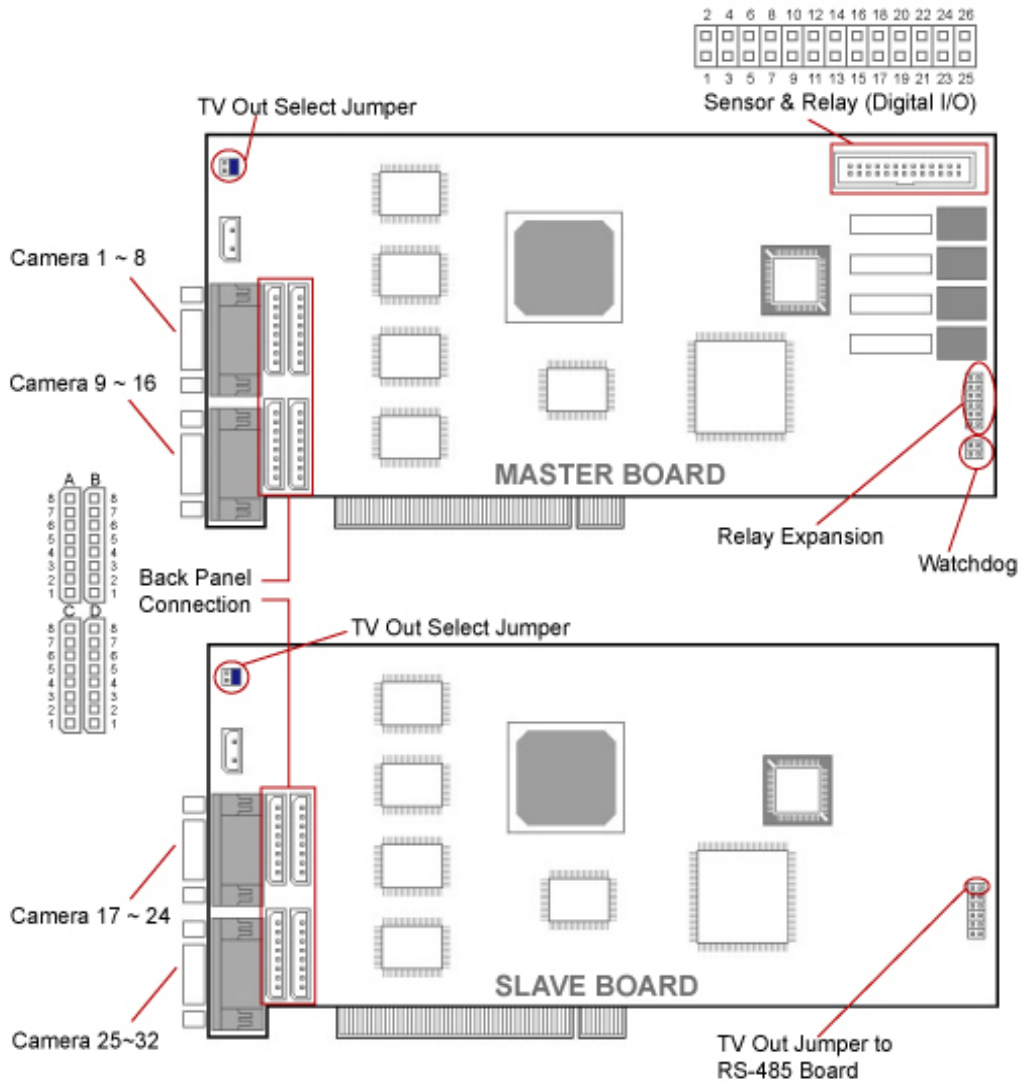

## 4. Installation

### 4-1. 120N16 / 240N16 / 12016LIV / 24016LIV Installation

#### 4-1-1. Pigtail Type

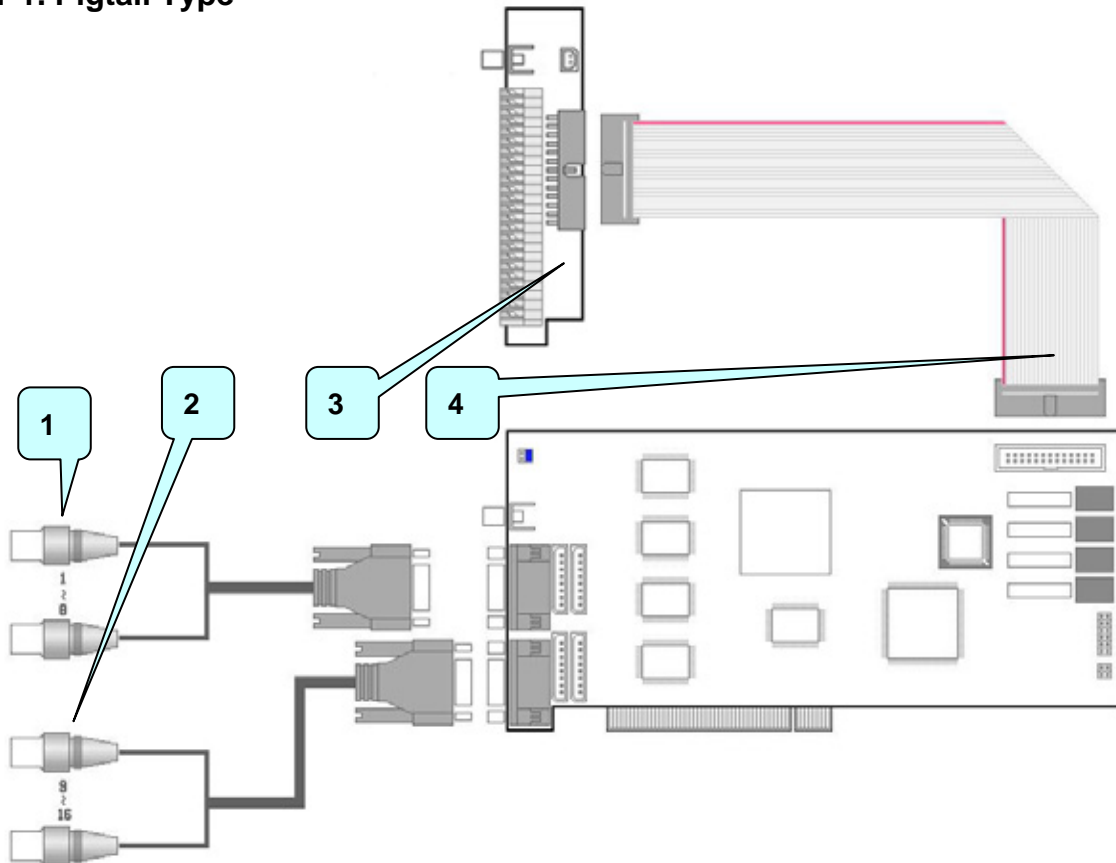

- 1) 1~8 channel pigtail goes to the upper socket.
- 2) 9~16 channel pigtail goes to the lower socket.
- 3) Sensor cable connects to Sensor port.
- 4) The other side of sensor cable connects to IO socket on the DVR board.
- 5) Connect Watchdog cable. Make Watchdog cable connection as shown below

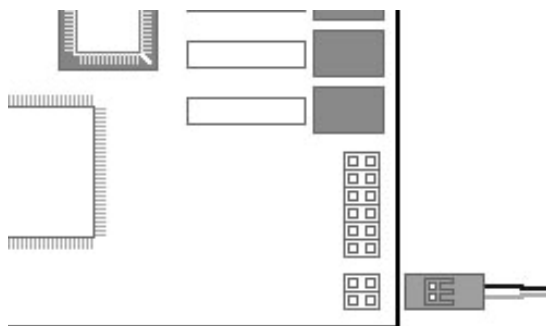

### 4-1-2. Back Panel Type

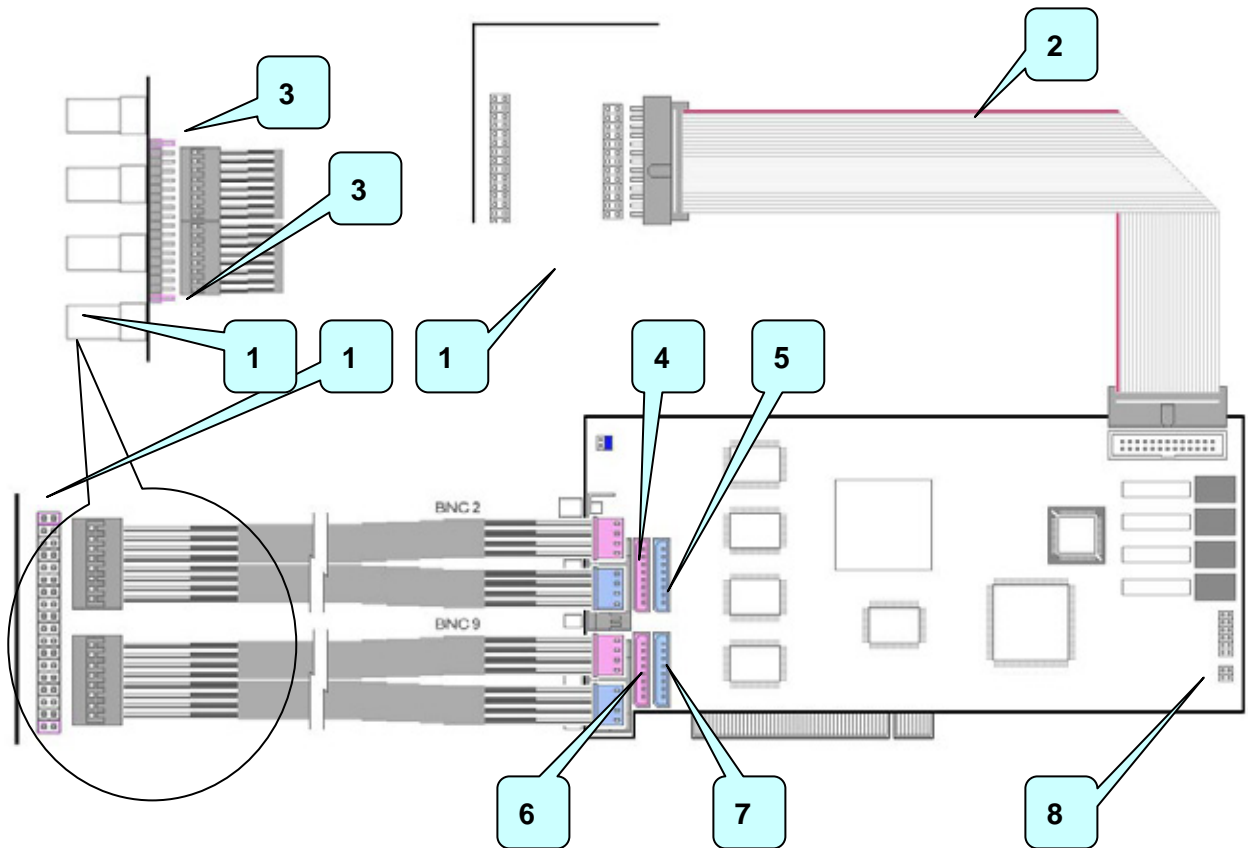

- 1) Back panel.
- 2) Sensor Cable.
- 3) When connect cable to back panel make sure to leave one pin from each end. White cable should be facing up.
- 4) Connect video cable with BNC2 label.
- 5) Connect another group of cable from video cable with BNC2 label.
- 6) Connect video cable with BNC9 label.
- 7) Connect another group of cable from video cable with BNC9 label.
- 8) Connect Watchdog cable. Make Watchdog cable connection as shown below

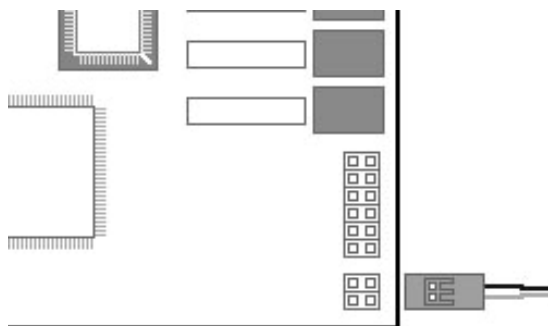

## 4-2. 240N32 Installation

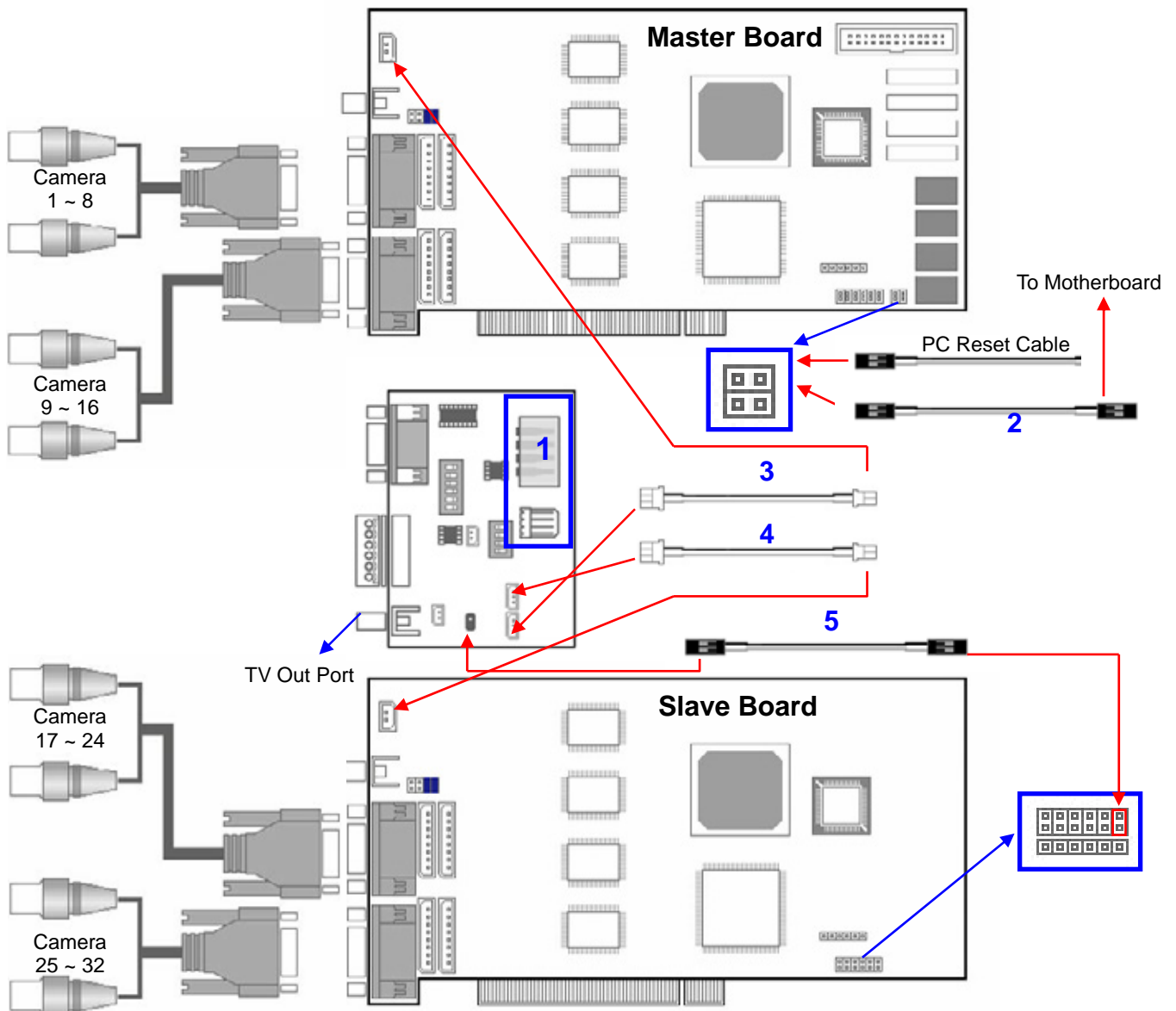

- 1) Power: Power connection for RX Converter. Make either one connection only.
- 2) Watchdog Cable
- 3) Video Out (1) : Connect Video Out from Master Board.
- 4) Video Out (2) : Connect Video Out from Slave Board.
- 5) Video Control : To control 16 Channel switching output.

On the Slave board, white cable goes to the top.

On the other side, black cable goes to the empty (no pin) side.

### 4-3. 480N32 Installation

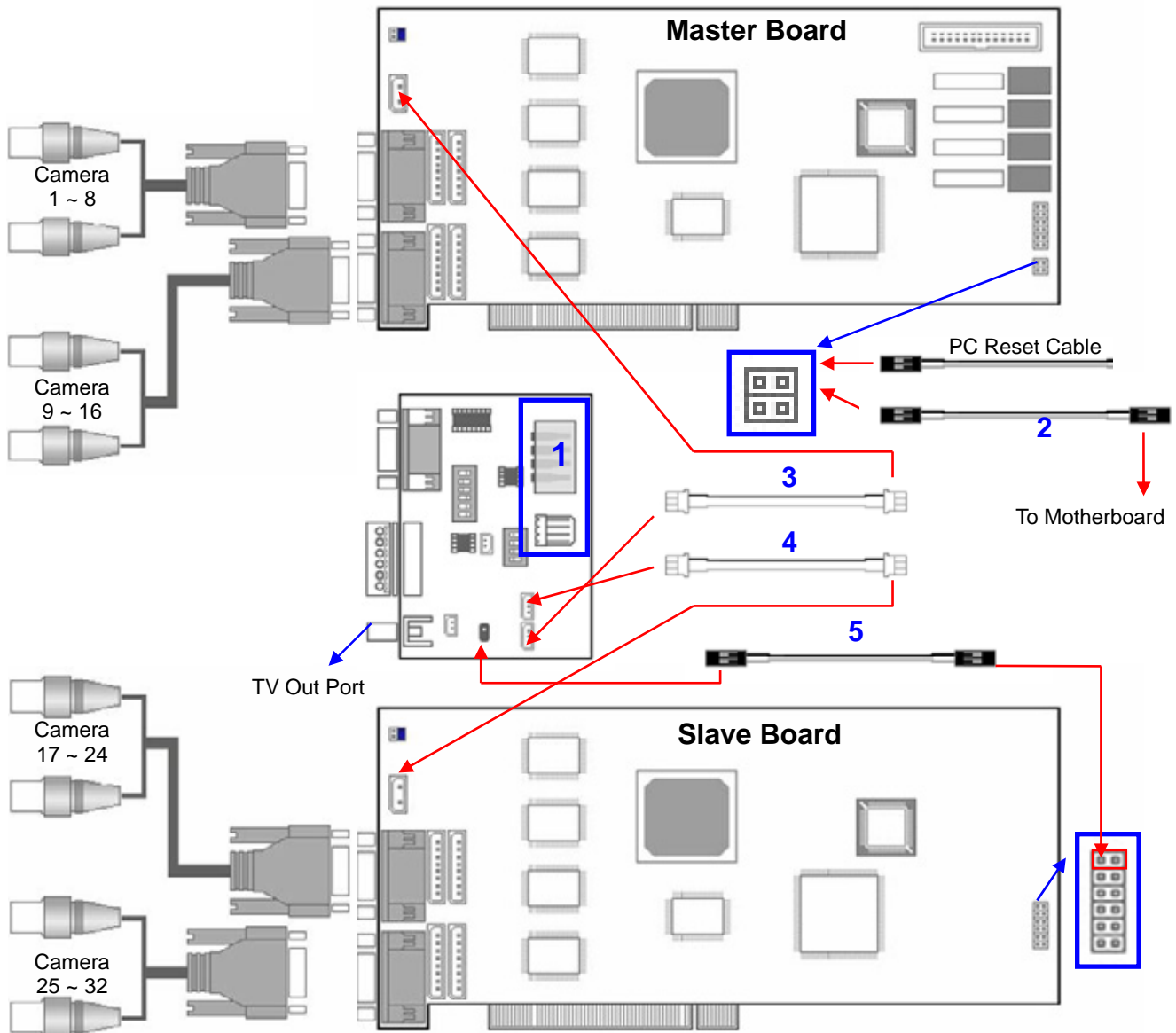

- 1) Power: Power connection for RX Converter. Make either one connection only.
- 2) Watchdog Cable
- 3) Video Out (1) : Connect Video Out from Master Board.
- 4) Video Out (2) : Connect Video Out from Slave Board.
- 5) Video Control : To control 16 Channel switching output.

On the Slave board, white cable goes to the left.

On the other side, black cable goes to the empty (no pin) side.

## 5. Accessories

### 5-1. Back Panel

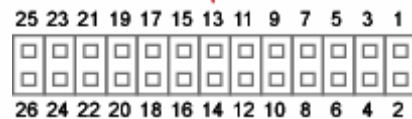
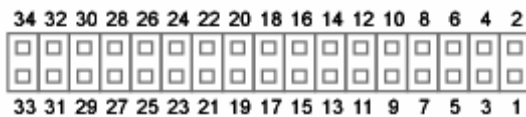
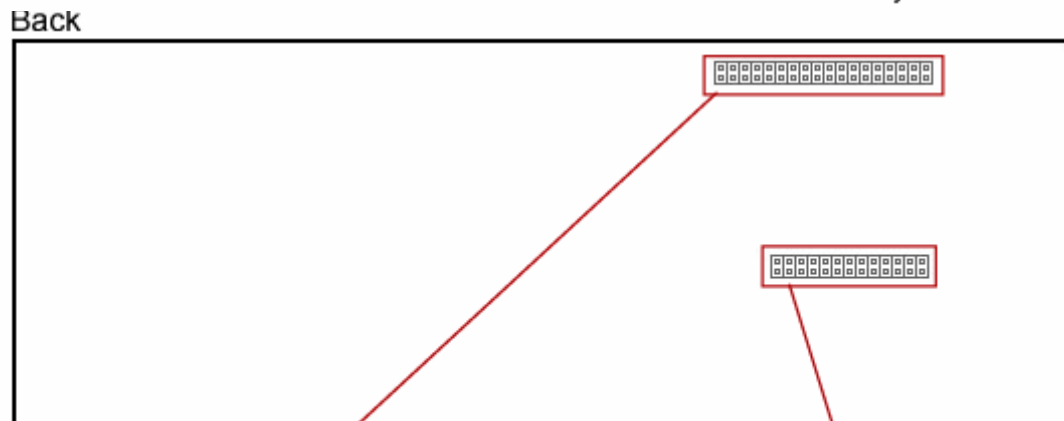
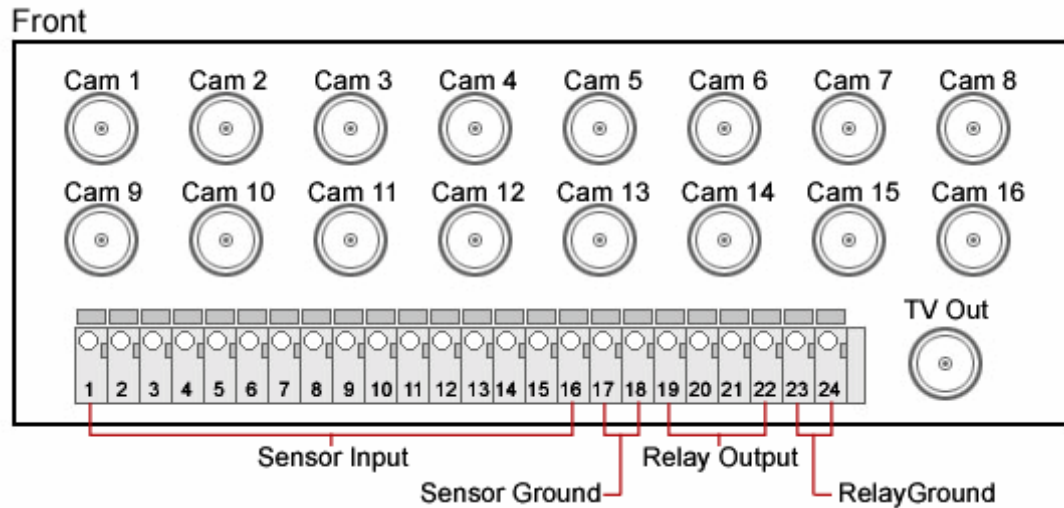

Camera I/O	
Camera Ground	3, 5, ~ 31, 33
Camera Signal	4, 6, ~ 32, 34
TV Out Ground	1
TV Out Signal	2

Sensor & Relay (Digital I/O)	
Sensor Input 0~15	1~16
Input Common 0~1	17, 18
Relay Output 0~3	19~22
Output Common 0~1	23, 24

## 5-2. Pigtail

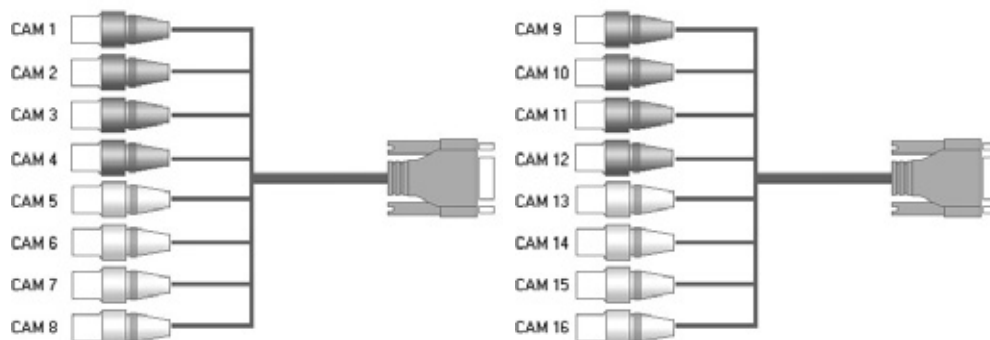

### Pigtail cable

1 ~ 4, 9 ~ 13 : Black BNC  
5 ~ 8, 13 ~ 16 : White BNC

## 5-3. Sensor Board

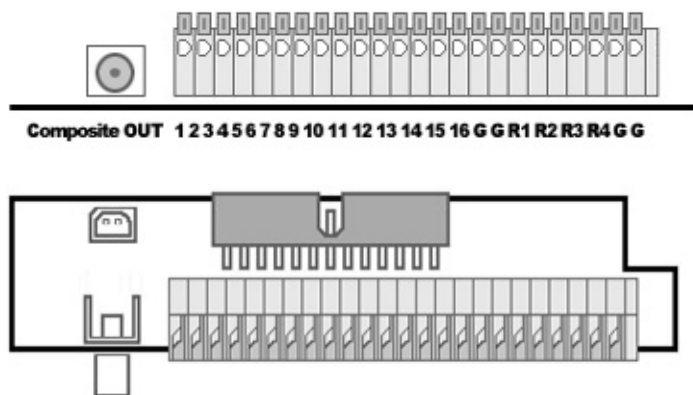

### Sensor port pin number

1 ~ 16 : Signal input  
G : Ground  
R1, R2, R3, R4 : Relay output



## 5-4. RS232 to RS422/485 Converter

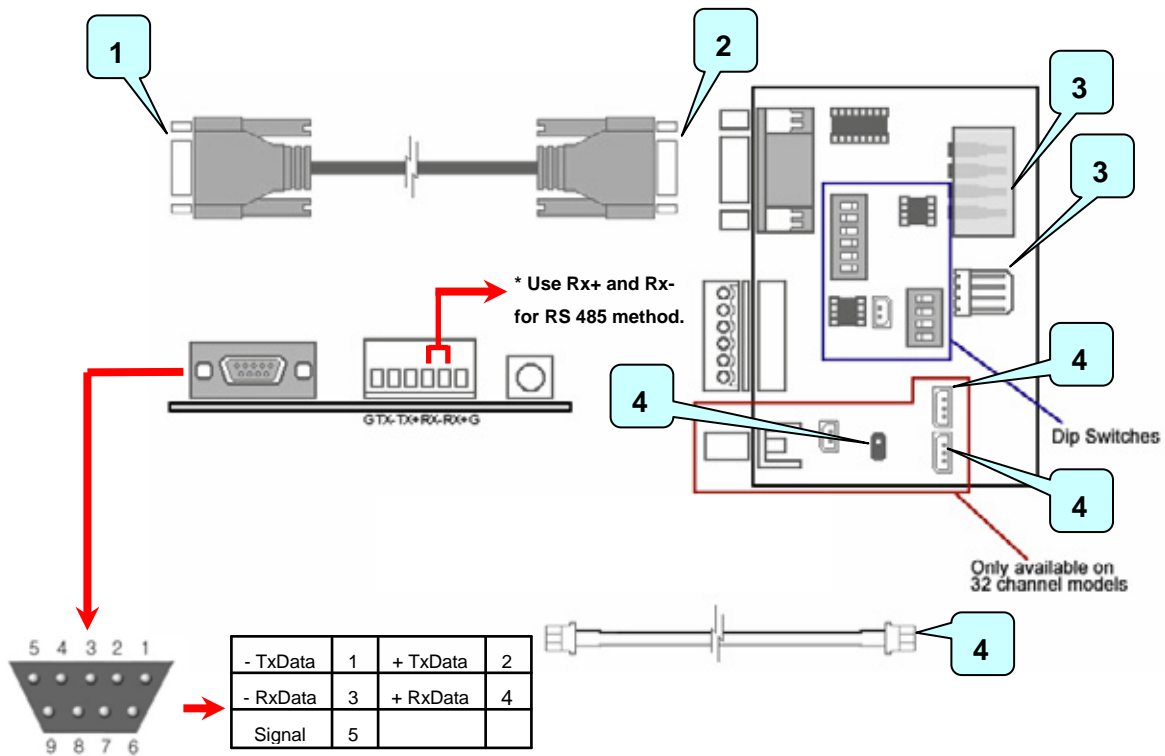

- 1) Connect to system's Com port.
- 2) Connect to PTZ port converter RS-485.
- 3) These are power supply sockets. Need to connect only one of them.
- 4) TV-Out Connection for 32 Channel board only.

### Dip Switches

#### RS-485 Mode

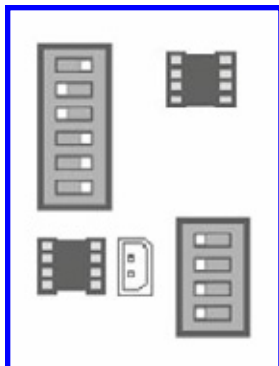

#### RS-422 Mode

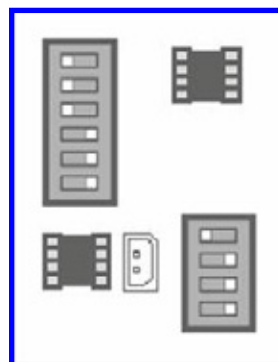

## 5-5. Sound Recording

After connecting Microphone, ensure that “Line In” and “Microphone In” is not muted in the Windows sound setting. It is required to *have Direct X 8.0 or higher*.

### 5-5-1. 1 Channel sound

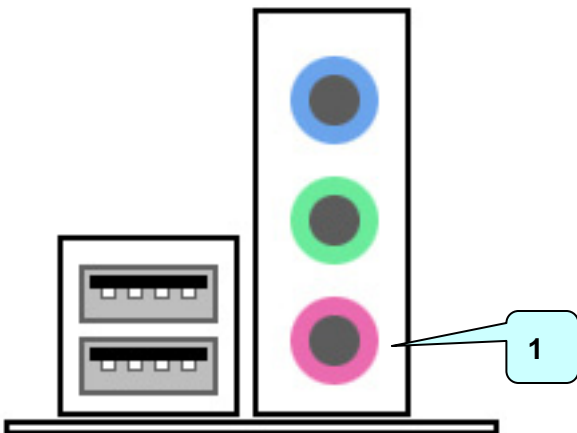

1) Connect to “Microphone In” of sound card.

### 5-5-2. 2 Channel sound

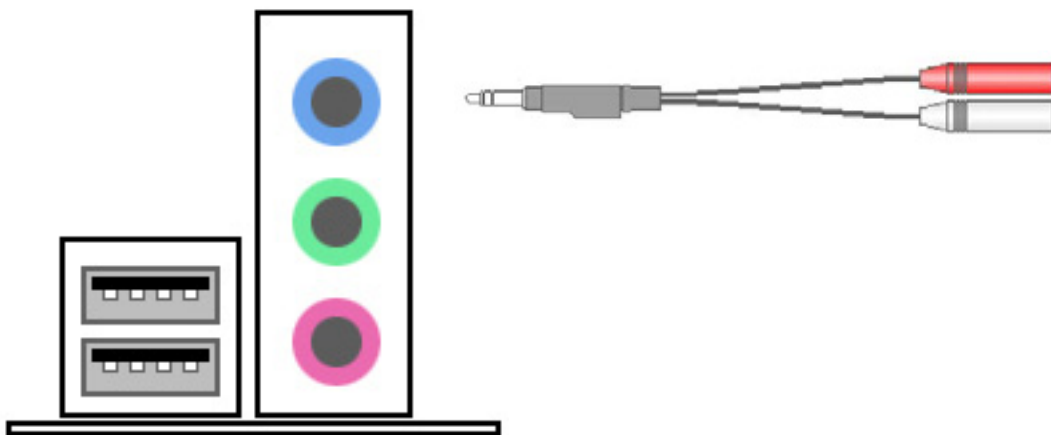

1) Connect to “Line In” of sound card with included 2 channel audio cable.

2) Connect microphones to the audio cable.

- Must use amplified microphone.